

E-Series 50 Ohm 20dB Coupler

5 – 1000 MHz

MACPES0054

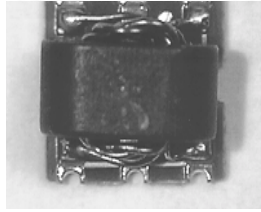

Features

- Low Intermod Distortion
- Coupling 20db Typical
- Surface Mount
- Tape and Reel Packaging available
- Internal 50Ω Termination.

Description

M/A-COM's MACPES0054 is a 50 Ohm 20dB Coupler with an internal 50 Ohm termination in a low cost, surface mount package. Ideally suited for high volume cellular, wireless applications.

SM-55 Package

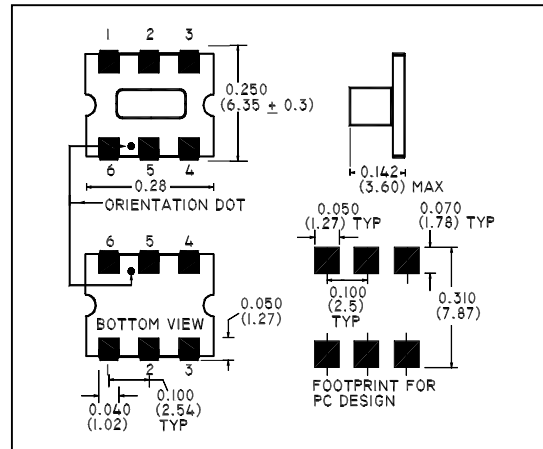

Schematic

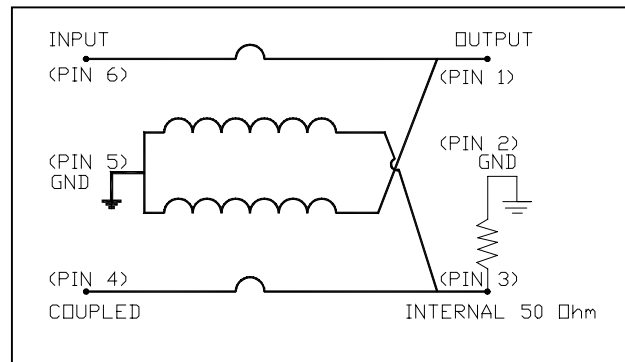

Electrical Specifications @ 25°C, Z₀ = 50 Ohms

Frequency Range	Test Conditions	Nominal	Units	Min.	Typ.	Max.
5 - 1000 MHz						
Mainline Loss	5 - 1000 MHz	—	dB	—	0.5	0.7
Mainline Loss Flatness	5 - 1000 MHz	—	dB	—	0.25	0.4
Coupling	5 - 1000 MHz	20	dB	—	—	±0.7
Coupling Flatness	5 - 1000 MHz	20	dB	—	—	±0.5
Isolation	5 - 1000 MHz	—	dB	30	35	—
Input Return Loss	5 - 40 MHz	—	dB	20	30	—
	40 - 1000 MHz	—	dB	15	20	—
Output Return Loss	5 - 40 MHz	—	dB	20	30	—
	40 - 1000 MHz	—	dB	15	20	—
Coupled Return Loss	5 - 1000 MHz	—	dB	20	25	—

Note: Specifications subject to change without notice.

Absolute Maximum Ratings

Parameter	Absolute Maximum
RF Power	250 mW
DC Current	30 mA
Storage Temperature	-40° C to +85°C
Operating Temperature	-40° C to +80°C

Operating Characteristics

Function	Pin No.
Input	6
Output	1
Coupled	4
Internal 50 Ohms (NOT CONNECTED)	3
Ground	2,5

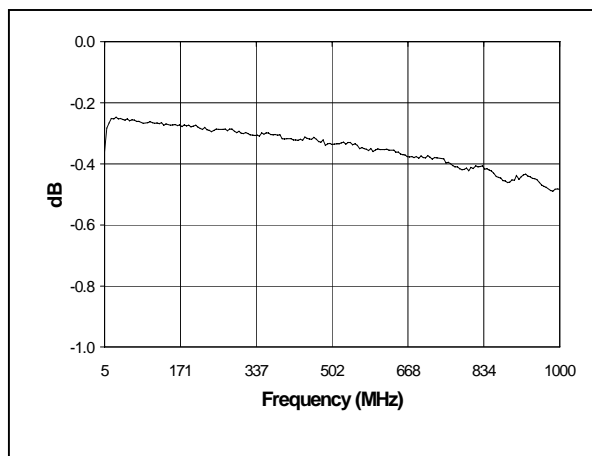
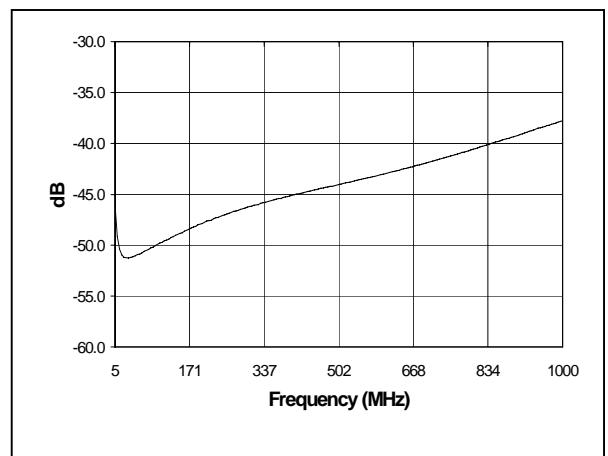
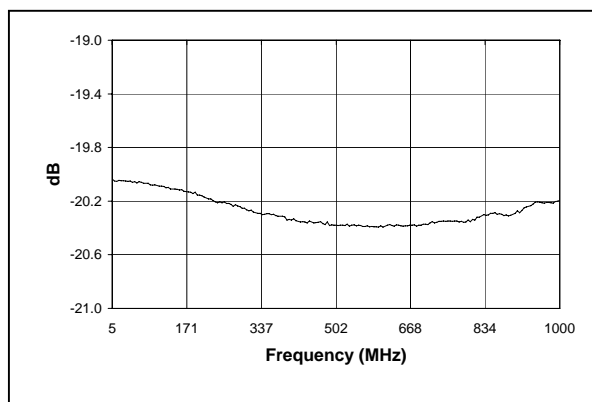
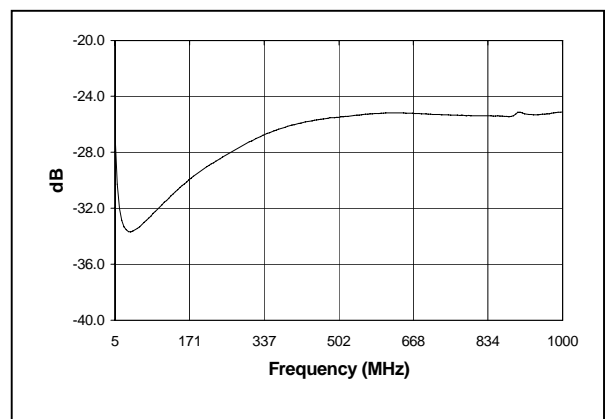
Typical Performance @ +25° C**Mainline Loss****Isolation****Coupling****Coupled Port Return Loss**

Rev A

Specifications subject to change without notice.

- North America: Tel. (800) 366-2266, Fax (800) 618-8883
- Asia/Pacific: Tel. +81-44-844-8296, Fax +81-44-844-8298
- Europe: Tel. +44 (1344) 869 595, Fax+44 (1344) 300 020

Visit www.macom.com for additional data sheets and product information.

tyco / Electronics

MACOM

Input Return Loss

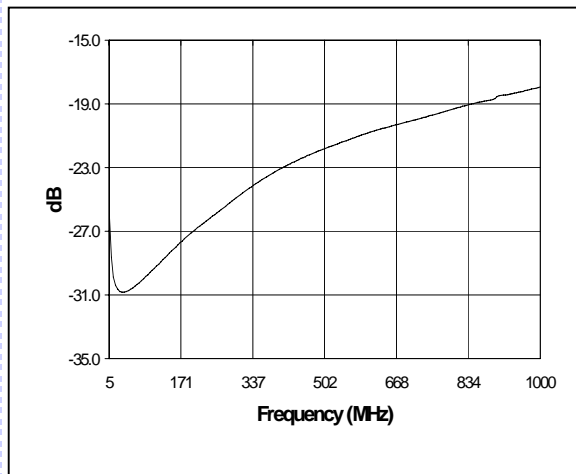

Output Return Loss

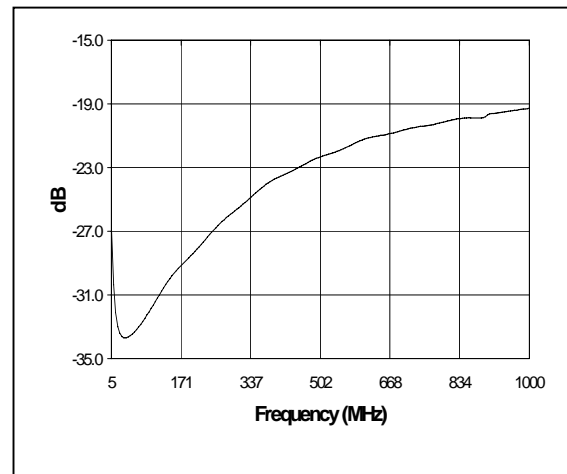

Specifications subject to change without notice.

- North America: Tel. (800) 366-2266, Fax (800) 618-8883
- Asia/Pacific: Tel.+81-44-844-8296, Fax +81-44-844-8298
- Europe: Tel. +44 (1344) 869 595, Fax+44 (1344) 300 020

Visit www.macom.com for additional data sheets and product information.

tyco / Electronics

MACOM